

ENTRAMADOS METÁLICOS

GRATINGS | CAILLEBOTIS MÉTALLIQUES

CARACTERÍSTICAS

CHARACTERISTICS | CARACTÉRISTIQUES



MATERIALES
RAW MATERIAL
MATIÈRE



FORMATO
DIMENSION
FORMAT



SEPARADOR (mm)
CROSS-BAR (mm)
SÉPARATEUR (mm)



MALLA
MESH | MAILLE



LARGO
LENGTH | LONGUEUR



ANCHO
WIDTH | LARGEUR



PLETINA PORTANTE (mm)
BEARING BAR (mm)
PLAT PORTEUR (mm)

MATERIALES

MATERIALS | MATIÈRE



GALVANIZADO EN CALIENTE
HOT DIP GALVANIZED
GALVANISÉ À CHAUD

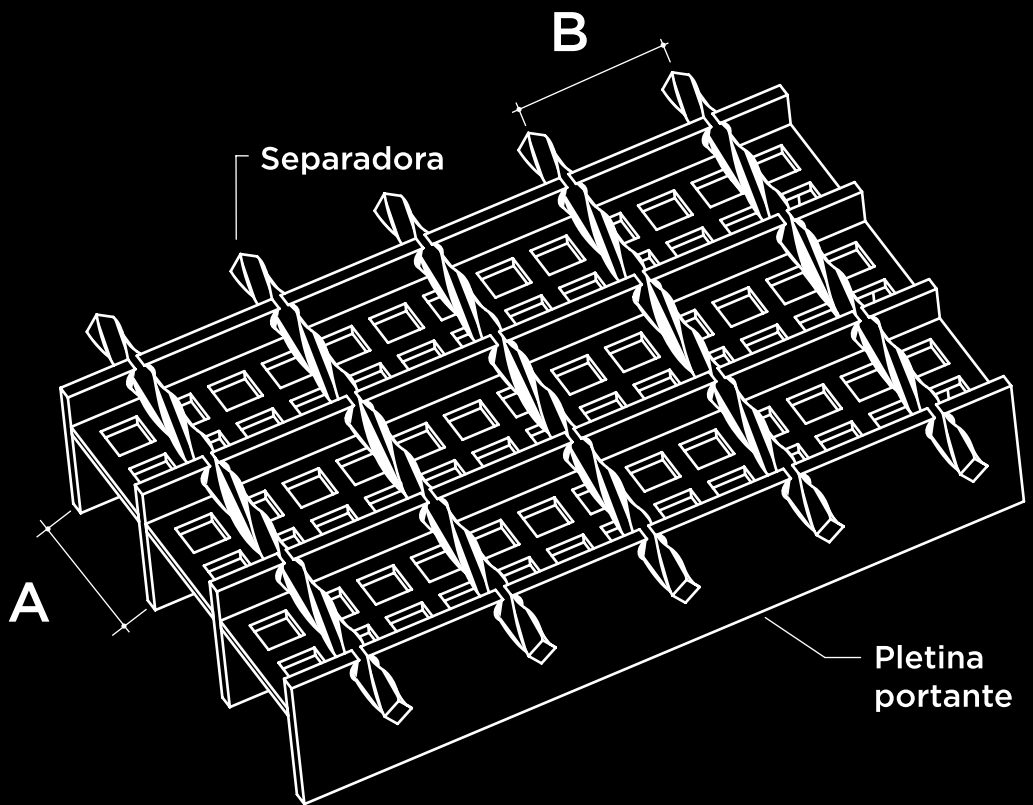

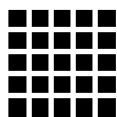





ENTRAMADOS METÁLICOS

GRATINGS | CAILLEBOTIS MÉTALLIQUES

ENTRAMADOS RECASOLD

GRATINGS RECASOLD | CAILLEBOTIS RECASOLD

					Pg.
30X30	25X2	Ø 5 MM.	2000X1000	G	122
30X30	30X2	Ø 5 MM.	200X1000	G	122
30X30	30X2	Ø 5 MM.	250X1000	G	122
30X30	30X2	Ø 5 MM.	300X1000	G	122
30X30	30X2	Ø 5 MM.	400X1000	G	122
30X30	30X2	Ø 5 MM.	500X1000	G	122
30X30	30X2	Ø 5 MM.	600X1000	G	122
30X30	30X2	Ø 5 MM.	700X1000	G	122
30X30	30X2	Ø 5 MM.	800X1000	G	122
30X30	30X2	Ø 5 MM.	900X1000	G	122
30X30	30X2	Ø 5 MM.	1000X1000	G	122
30X30	30X2	Ø 5 MM.	1200X1000	G	122
30X30	30X2	Ø 5 MM.	1500X1000	G	122
30X30	30X2	Ø 5 MM.	2000X1000	G	122
30X30	30X2	Ø 5 MM.	2500X1000	G	122
30X30	30X2	Ø 5 MM.	3000X1000	G	122
30X30	30X3	Ø 5 MM.	250X1000	G	122
30X30	30X3	Ø 5 MM.	300X1000	G	122
30X30	30X3	Ø 5 MM.	400X1000	G	122
30X30	30X3	Ø 5 MM.	1000X1000	G	122
30X30	30X3	Ø 5 MM.	1200X1000	G	122
30X30	30X3	Ø 5 MM.	1500X1000	G	122
30X30	30X3	Ø 5 MM.	2000X1000	G	122
30X30	30X3	Ø 5 MM.	3000X1000	G	122
30X30	40X3	Ø 5 MM.	2000X1000	G	122

*En Stock. La primera medida indica el sentido de la pletina portante. Posibilidad de fabricación a medida bajo pedido.

*In stock. The first measurement indicates the bearing bar direction. Special dimensions upon request.

*En stock. La première mesure indique le sens du plat porteur. Autres dimensions sur demande

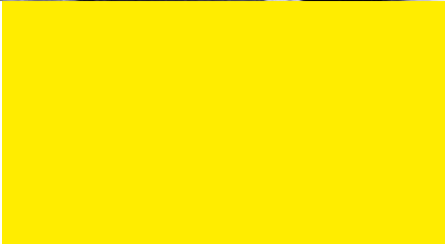
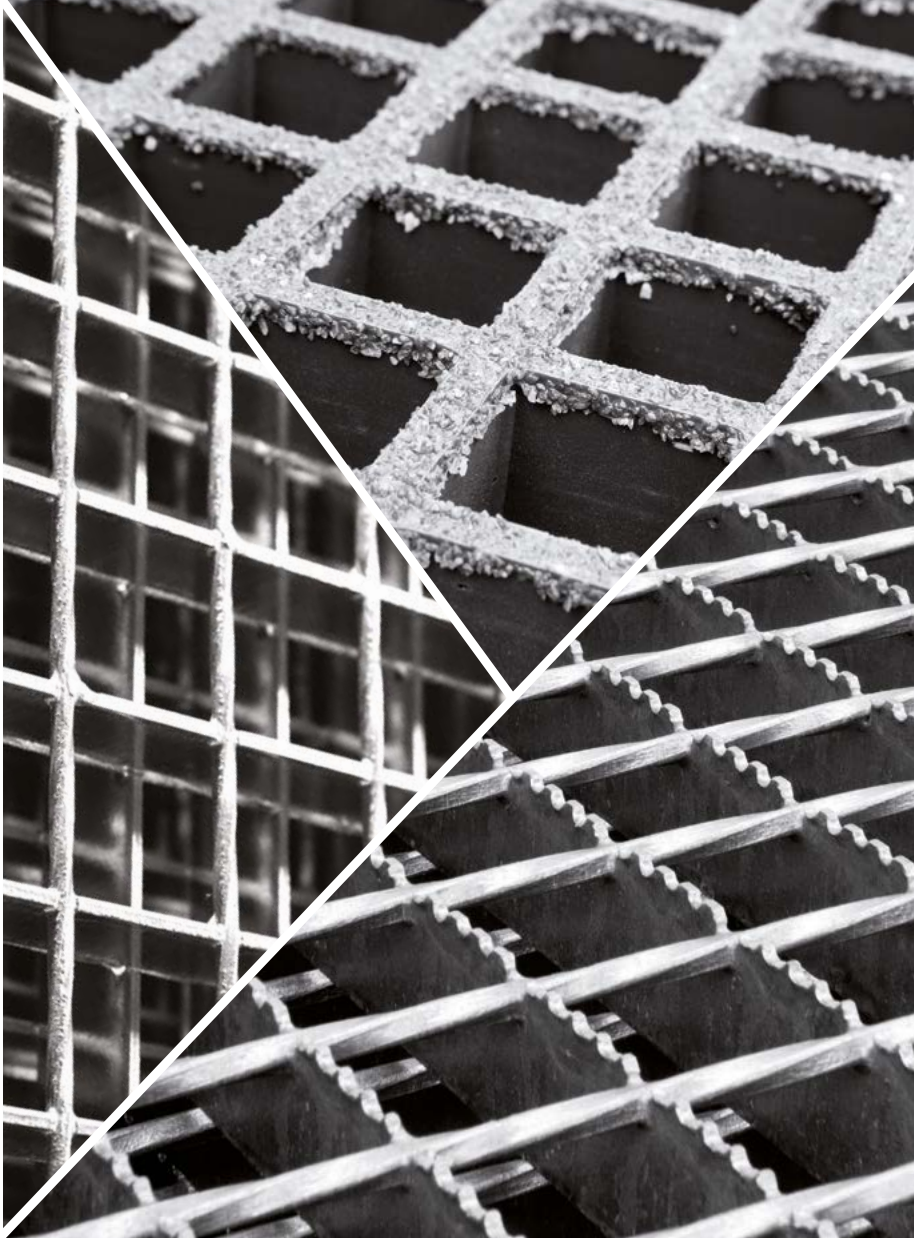
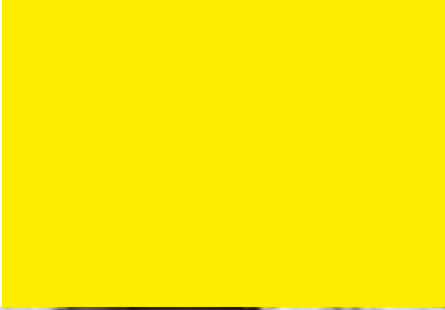

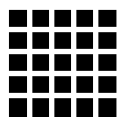

ENTRAMADOS METÁLICOS

GRATINGS | CAILLEBOTIS MÉTALLIQUES

PELDAÑOS RECASOLD

RECASOLD STAIRS | MARCHES RECASOLD

					Pg.
30x30	30x2	Ø 5 mm.	600X240		122
30x30	30x2	Ø 5 mm.	700X240		122
30x30	30x2	Ø 5 mm.	700X270		122
30x30	30x2	Ø 5 mm.	800X240		122
30x30	30x2	Ø 5 mm.	800X270		122
30x30	30x3	Ø 5 mm.	900X270		122
30x30	30x3	Ø 5 mm.	1000X270		122
30x30	30x3	Ø 5 mm.	1000X300		122
30x30	30x3	Ø 5 mm.	1200X300		122

ENTRAMADOS RECASOLD CON MALLA DE SEGURIDAD

SECURITY MESH RECASOLD GRATINGS | CAILLEBOTIS RECASOLD AVEC MAILLE DE SÉCURITÉ

					Pg.
30x30	30x2	Ø 5 mm.	500X1000		122
30x30	30x2	Ø 5 mm.	600X1000		122
30x30	30x2	Ø 5 mm.	700X1000		122
30x30	30x2	Ø 5 mm.	800X1000		122
30x30	30x2	Ø 5 mm.	1000X1000		122
30x30	30x2	Ø 5 mm.	2000X1000		122
30x30	30x3	Ø 5 mm.	1000X1000		122
30x30	30x3	Ø 5 mm.	1200X1000		122
30x30	30x3	Ø 5 mm.	1500X1000		122
30x30	30x3	Ø 5 mm.	2000X1000		122







*En Stock. La primera medida indica el sentido de la pletina portante. Posibilidad de fabricación a medida bajo pedido.

*In stock. The first measurement indicates the bearing bar direction. Special dimensions upon request.

*En stock. La première mesure indique le sens du plat porteur. Autres dimensions sur demande

PELDAÑOS RECASOLD DE SEGURIDAD

SECURITY MESH RECASOLD STAIRS | MARCHES RECASOLD AVEC MAILLE DE SÉCURITÉ

					Pg.
30x30	30x2	Ø 5 mm.	800X240		122
30x30	30x3	Ø 5 mm.	900X270		122
			1000X270		122
			1000X300		122













ENTRAMADOS RECASOLD DENTADO

SERRATED RECASOLD GRATINGS | CAILLEBOTIS RECASOLD CRANTÉS

					Pg.
30x30	30x2 dentada	Ø 5 mm.	2000x1000		123

ENTRAMADOS RECA

RECA GRATINGS | CAILLEBOTIS RECA

					Pg.
30x30	25x2	10x2	500x1000		123
			1000x1000		123
			2000x1000		123
30x30	30x2	10x2	1000x1000		123
			2000x1000		123
			3000x1000		123
30x30	30x2	30x2	2000x1000		124
30x30	30x3	30x3	2000x1000		124

*En Stock. La primera medida indica el sentido de la pletina portante. Posibilidad de fabricación a medida bajo pedido.

*In stock. The first measurement indicates the bearing bar direction. Special dimensions upon request.

*En stock. La première mesure indique le sens du plat porteur. Autres dimensions sur demande



ENTRAMADO RECASOLD PLETINA + VARILLA

ELECTRO-WELDED GRATINGS | CAILLEBOTIS ÉLECTROFORGÉS

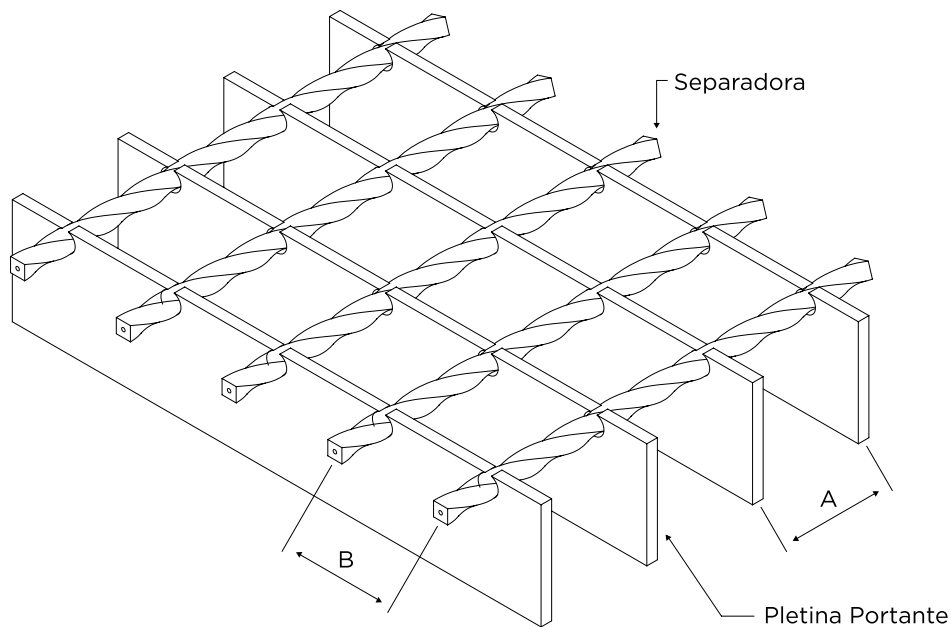

ENTRAMADO RECASOLD PLETINA + VARILLA + MALLA SEGURIDAD

SECURITY MESH RECASOLD GRATINGS | CAILLEBOTIS RECASOLD AVEC MAILLE DE SÉCURITÉ.

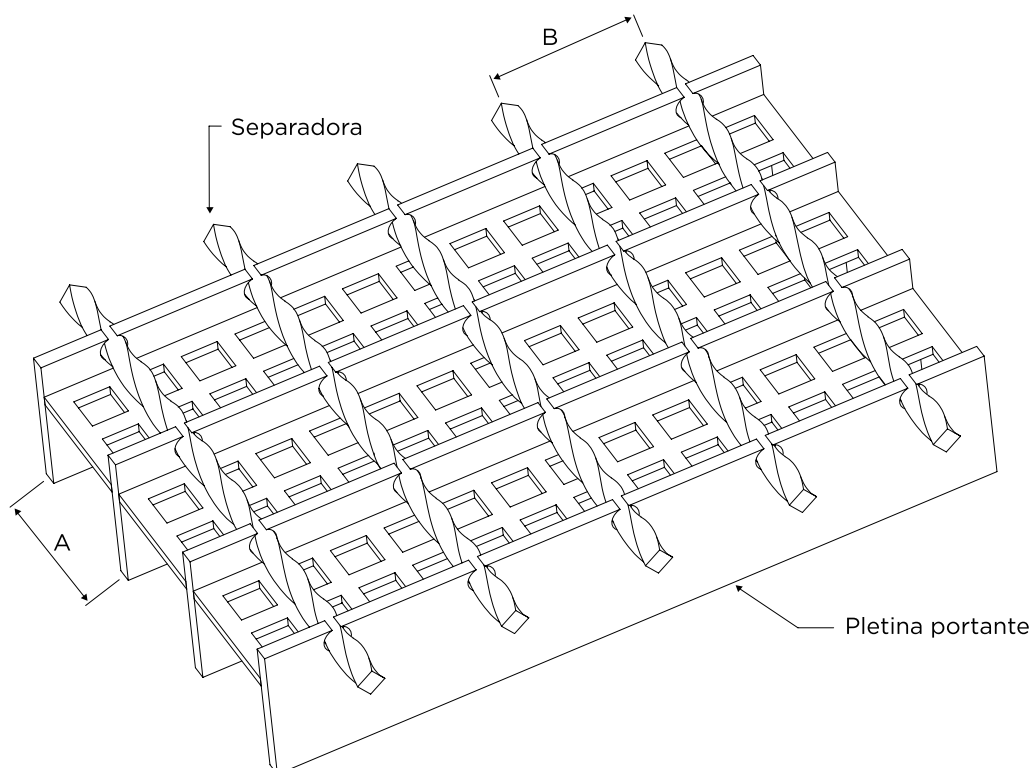

ENTRAMADO RECASOLD PLETINA DENTADA + VARILLA

SERRATED RECASOLD GRATINGS | CAILLEBOTIS RECASOLD CRANTÉS

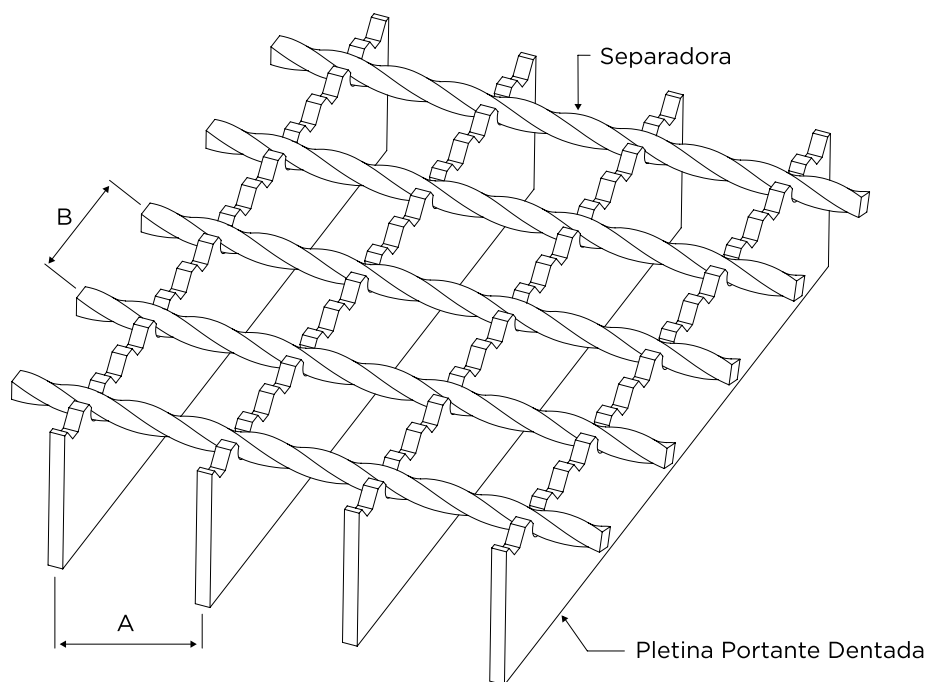

ENTRAMADO RECA PLETINA + SEMIPLLETINA

BEARING BAR + HALF FILLER BAR RECA GRATINGS | CAILLEBOTIS RECA PORTANTE + DEMI-BARRE

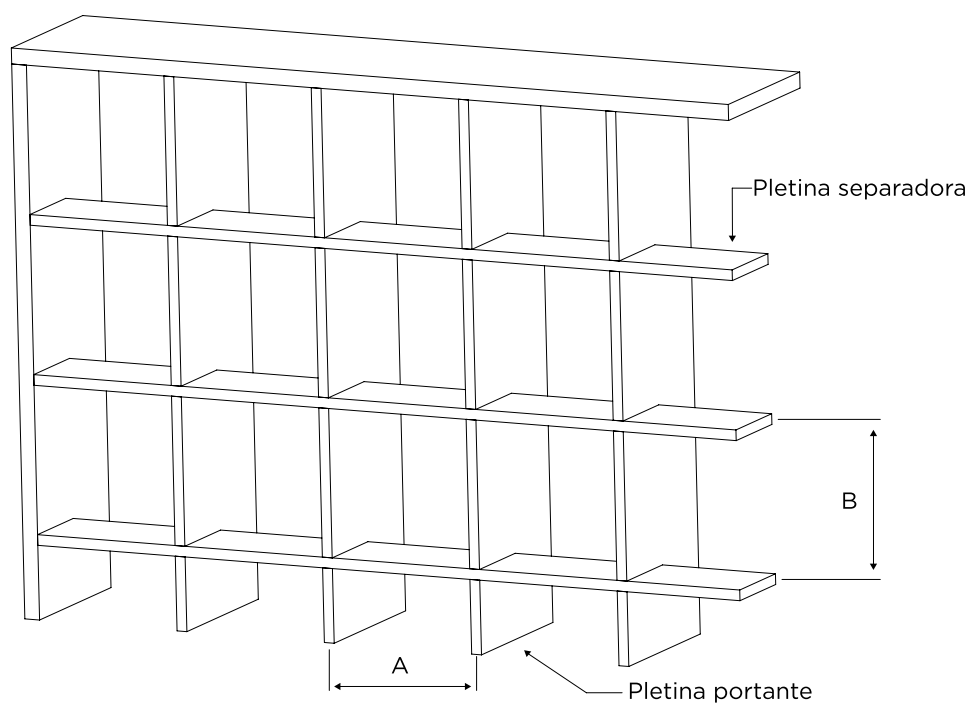

ENTRAMADO RECA DOBLE PLETINA

FULL RECA GRATINGS | CAILLEBOTIS RECA DOUBLE BARRE

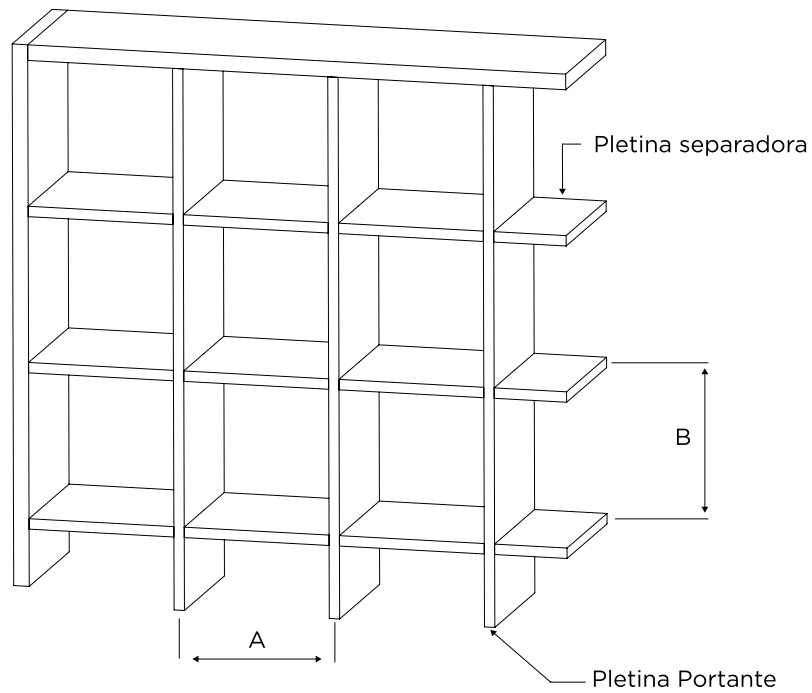

ENTRAMADO RECA TIPO PERSIANA

RECA "LOUVRE" GRATINGS | CAILLEBOTIS RECA À LAMES INCLINÉES



TABLA DE CARGAS 30x30 | LOADING TABLE 30X30 | TABLEAU DES CHARGES 30X30

DIMENSIONES DE LAS PLETINAS PORTANTES EN mm.

BEARING BAR SIZE | DIMENSION PORTANTE

DISTANCIA ENTRE APOYOS		20X3	25x2	25x3	30x2	30x3	40X3	40X4	50X3	50X4
500	Fv	2983	3110	4665	4478	6717	11942	15922	18659	24879
	Fp	257	267	401	382	573	1002	1336	1542	2056
600	Fv	2071	2160	3239	3110	4665	8293	11057	12958	17277
	Fp	205	214	321	306	459	802	1069	1234	1645
700	Fv	1522	1587	2380	2285	3427	6093	8124	9520	12693
	Fp	171	178	267	255	382	668	891	1028	1371
800	Fv	1165	1215	1822	1749	2624	4665	6220	7289	9718
	Fp	147	153	229	218	328	573	764	881	1175
900	Fv	921	960	1440	1382	2073	3686	4914	5759	7679
	Fp	128	134	201	191	287	501	668	771	1028
1000	Fv		777	1166	1120	1679	2985	3981	4665	6220
	Fp		119	178	170	255	445	594	685	914
1100	Fv		643	964	925	1388	2467	3290	3855	5140
	Fp		107	160	153	229	401	535	617	822
1200	Fv		540	810	777	1166	2073	2764	3239	4319
	Fp		97	146	139	208	364	486	561	748
1300	Fv		460	690	662	994	1767	2355	2760	3680
	Fp		89	134	127	191	334	445	514	685
1400	Fv		397	595	571	857	1523	2031	2380	3173
	Fp		82	123	118	176	308	411	475	633
1500	Fv		346	518	498	746	1327	1769	2073	2764
	Fp		76	115	109	164	286	382	441	587
1600	Fv		304	456	437	656	1166	1555	1822	2430
	Fp		71	107	102	153	267	356	411	548
1700	Fv		269	404	387	581	1033	1377	1614	2152
	Fp		67	100	96	143	251	334	386	514
1800	Fv		240	360	346	518	921	1229	1440	1920
	Fp		63	94	90	135	236	314	363	484
1900	Fv		215	323	310	465	827	1103	1292	1723
	Fp		59	89	85	127	223	297	343	457
2000	Fv		194	292	280	420	746	995	1166	1555
	Fp		56	84	80	121	211	281	325	433

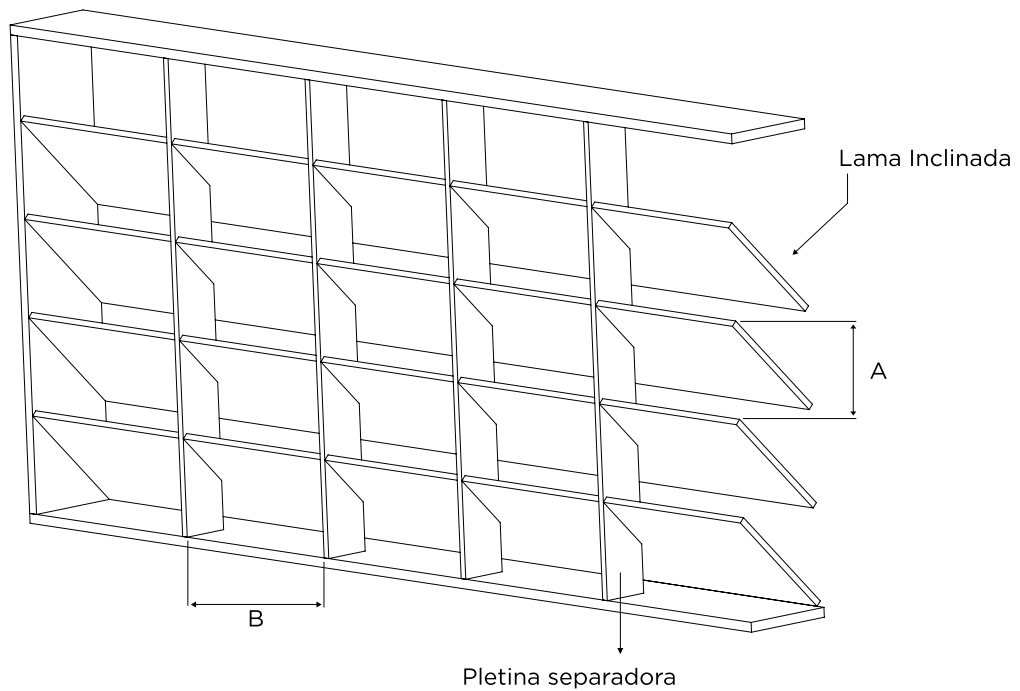
Fv: Carga uniformemente repartida en kg/m2. Value of constant load in kg/m2. | Valeurs pour charge uniformément répartie en kg/m2.

Fp: Carga en kgs. concentrada sobre una superficie de 200x200 mm. Value of the load concentrated in kg. on a surface of 200x200 mm. | Valeurs pour charge concentrée pour un impact de 200x200 mm (en kg)

Apto para paso de peatones. Suitable for foot traffic | Apte pour passage de piétons

RECA CONTACTO

CONTACT | NOUS CONTACTER



BARCELONA

Sant Martí, s/n
Pol. Ind. de Martorelles
08107 Martorelles
Tel.: 93 570 66 77
Fax: 93 570 09 78
Tel. Export.: +34 93 570 67 98
Fax Export.: +34 93 579 24 83
reca@reca.es - www.reca.es

MADRID

Avda. Madrid 26 nave 15, 16
Pol. Ind. Albresa
28342 Valdemoro
Tel.: 91 614 90 00
Fax: 91 614 96 52
madrid@reca.es
www.reca.es

JAÉN

Fersan Gestiones Siderúrgicas
Calle de la Dehesa, nave 16
Pol. Ind. Pilar de la Dehesa
23006 Jaén
Tel.: 653754736
Fax: 953 25 99 12
infogesider@gmail.com
www.reca.es

ASTURIAS

MCHC
Avda. Xuvería, 22
33211 Gijón
Tel.: 98 530 89 91
Fax: 98 530 89 92
mchc@mchc.es
www.reca.es

VALLADOLID

Faustino González e Hijos
Pol. Ind. San Cristóbal
Topacio, 15, parcela 78
47012 Valladolid
Tel.: 98 320 31 90
Fax: 98 329 06 76
faustinogonzalez@
faustinogonzalez.es
www.reca.es

SEVILLA

Calle 4, parcela 4
Pol. Ind. Fridex
41500 Alcalá de Guadaíra
Tel.: 95 563 01 67
rociomd@resian.es
www.reca.es

PORTUGAL

PERFOMETAL, Ltda.
Avda. Irene Lisboa, 32-E
Alto do Forte
2635-001 Rio do Mouro
Tel.: +35 12 19 16 95 30
Fax: +35 12 19 16 95 39
geral@perfometal.pt
www.perfometal.pt

FRANCIA

SARL PLA GASSOL
6 Avenue Ferdinand
de Lesseps
33610 Canejan
Tel.: 05 56 87 56 56
Fax: 05 56 87 89 18
devis@plagassol.fr
www.reca.es

ITALIA

Trentaquattrotrentotto SRL
Via Provinciale 56
23879 Verderio (LC)
Tel.: 039 951 59 51
Fax: 039 330 58 39
trentaquattro38@yahoo.it
www.reca.es

RECA CONTACTO

CONTACT | NOUS CONTACTER



